

# IBM ThinkVision™ Monitor L180p

---



**L180p**

---

User's Guide

English

---

## **First Edition (January/2004)**

Note: For important information, refer to the Monitor Safety and Warranty manual that comes with this monitor.

# Contents

<b>Safety (Read first)</b> .....	<b>2</b>
<b>Setting up the monitor</b> .....	<b>5</b>
Product description .....	5
Handling instructions.....	5
Kensington security slot .....	6
Workplace preparation .....	7
Adjusting the monitor position .....	7
Working practices.....	8
Caring for your monitor .....	8
Connecting your monitor.....	9
Switching on your monitor.....	10
<b>Device driver installation</b> .....	<b>11</b>
Windows 95/98.....	11
Windows 2000/Me.....	12
Windows XP .....	13
<b>Automatic Image setup</b> .....	<b>14</b>
Image setup .....	14
Image setup for DOS .....	15
Image setup for Windows 95, Windows 98, Windows 2000, Windows NT, Windows Me, or Windows XP .....	16
<b>Manual Image setup</b> .....	<b>17</b>
<b>Adjusting your LCD monitor</b> .....	<b>18</b>
User controls.....	18
On-screen display (OSD) controls .....	19
<b>Further information</b> .....	<b>22</b>
Display modes .....	22
Power management.....	23
Product disposal .....	23
<b>Arm or wall mounting</b> .....	<b>24</b>
<b>Troubleshooting</b> .....	<b>25</b>
Help and service information .....	27
<b>Specifications</b> .....	<b>28</b>
<b>Service information</b> .....	<b>29</b>
<b>Notices and trademarks</b> .....	<b>30</b>

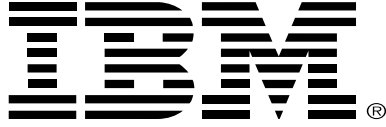

## **Safety: Read first**

Before installing this product, read the Safety Information.

Avant d'installer ce produit, lisez les consignes de sécurité.

Vor der Installation dieses Produkts die Sicherheitshinweise lesen.

Πριν εγκαταστήσετε το προϊόν αυτό, διαβάστε τις πληροφορίες ασφάλειας (safety information).

לפני שתתקינו מוצר זה, קראו את הוראות הבטיחות.

A termék telepítése előtt olvassa el a Biztonsági előírásokat!

Prima di installare questo prodotto, leggere le Informazioni sulla Sicurezza

Antes de instalar este produto, leia as Informações de Segurança.

Läs säkerhetsinformationen innan du installerar den här produkten.

Prije instalacije ovog produkta obavezno pročitajte Sigurnosne Upute.

Les sikkerhetsinformasjonen (Safety Information) før du installerer dette produktet.

Przed zainstalowaniem tego produktu, należy zapoznać się z książką "Informacje dotyczące bezpieczeństwa" (Safety Information).

Пред да се инсталира овој продукт, прочитајте информацијата за безбедност.

Před inštaláciou tohto zariadenia si prečítajte Bezpečnostné predpisy.

Pred namestitvijo tega proizvoda preberite Varnostne informacije.

Ennen kuin asennat tämän tuotteen, lue turvaohjeet kohdasta Safety Information.

Před instalací tohoto produktu si přečtěte příručku bezpečnostních instrukcí.

在安裝本產品之前，請仔細閱讀 Safety Information (安全信息)。

安裝本產品之前，請先閱讀「安全資訊」。

مج، يجب قراءة دات السلامة

Læs sikkerhedsforskrifterne, før du installerer dette produkt.

製品を設置する前に、安全情報をお読みください。

본 제품을 설치하기 전에 안전 정보를 읽으십시오.

Antes de instalar este producto lea la información de seguridad.

Antes de instalar este produto, leia as Informações de Segurança.

Перед установкой продукта прочтите инструкции по технике безопасности.

Lees voordat u dit product installeert eerst de veiligheidsvoorschriften.

Always observe the following precautions to reduce the risk of injury and property damage.

Do not attempt to service a product yourself unless instructed to do so by the IBM Support Center. Use only an IBM authorized service provider who is approved to repair your particular product.

**Note:** Some parts can be upgraded or replaced by the customer. These parts are referred to as Customer Replaceable Units, or CRUs. IBM expressly identifies CRUs as such, and provides documentation with instructions when it is appropriate for customers to replace those parts. You must closely follow all instructions when performing such replacements. Always make sure that the power is turned off and that the product is unplugged from any power source before you attempt the replacement. If you have any questions or concerns, contact the IBM Support Center.

Use only the power cords and power adapters supplied by the product manufacturer.

Never wrap a power cord around the power adapter or other object. Doing so can stress the cord in ways that can cause the cord to fray, crack or crimp. This can present a safety hazard.

Always route power cords so that they will not be walked on, tripped over, or pinched by objects.

Protect the cord and power adapters from liquids. For instance, do not leave your cord or power adapter near sinks, tubs, toilets, or on floors that are cleaned with liquid cleansers. Liquids can cause a short circuit, particularly if the cord or power adapter has been stressed by misuse. Liquids can also cause gradual corrosion of the power cord terminals and/or the connector terminals on the adapter which can eventually result in overheating.

Always connect power cords and signal cables in the correct order and ensure that all power cord connectors are securely and completely plugged into receptacles.

Do not use any power adapter that shows corrosion at the ac input pins and/or shows signs of overheating (such as deformed plastic) at the ac input or anywhere on the power adapter.

Do not use any power cords where the electrical contacts on either end show signs of corrosion or overheating or where the power cord appears to have been damaged in any way.

Ensure that extension cords, surge protectors, uninterruptible power supplies, and power strips that you use are rated to handle the electrical requirements of the product. Never overload these devices. If power strips are used, the load should not exceed the power strip input rating. Consult an electrician for more information if you have questions about power loads, power requirements, and input ratings.

If a receptacle (power outlet) that you intend to use with your computer equipment appears to be damaged or corroded, do not use the outlet until it is replaced by a qualified electrician.

Do not bend or modify the plug. If the plug is damaged, contact the manufacturer to obtain a replacement.

Some products are equipped with a three-pronged plug. This plug fits only into a grounded electrical outlet. This is a safety feature. Do not defeat this safety feature by trying to insert it into a non-grounded outlet. If you cannot insert the plug into the outlet, contact an electrician for an approved outlet adapter or to replace the outlet with one that enables this safety feature. Never overload an electrical outlet. The overall system load should not exceed 80 percent of the branch circuit rating. Consult an electrician for more information if you have questions about power loads and branch circuit ratings.

Be sure that the power outlet you are using is properly wired, easily accessible, and located close to the equipment. Do not fully extend power cords in a way that will stress the cords.

Connect and disconnect the equipment from the electrical outlet carefully

All IBM personal computers contain a non-rechargeable coin cell battery to provide power to the system clock. In addition many mobile products such as ThinkPad notebook PCs utilize a rechargeable battery pack to provide system power when in portable mode. Batteries supplied by IBM for use with your product have been tested for compatibility and should only be replaced with IBM approved parts.

Never attempt to open or service any battery. Do not crush, puncture, or incinerate batteries or short circuit the metal contacts. Do not expose the battery to water or other liquids. Only recharge the battery pack strictly according to instructions included in the product documentation.

Battery abuse or mishandling can cause the battery to overheat, which can cause gasses or flame to "vent" from the battery pack or coin cell. If your battery is damaged, or if you notice any discharge from your battery or the buildup of foreign materials on the battery leads, stop using the battery and obtain a replacement from the battery manufacturer.

Batteries can degrade when they are left unused for long periods of time. For some rechargeable batteries (particularly Lithium Ion batteries), leaving a battery unused in a discharged state could increase the risk of a battery short circuit, which could shorten the life of the battery and can also pose a safety hazard. Do not let rechargeable Lithium-Ion batteries completely discharge or store these batteries in a discharged state.

Computers generate heat when turned on and when batteries are charging. Notebook PCs can generate a significant amount of heat due to their compact size. Always follow these basic precautions:

- Do not leave the base of your computer in contact with your lap or any part of your body for an extended period when the computer is functioning or when the battery is charging. Your computer produces some heat during normal operation. Extended contact with the body could cause discomfort or, potentially, a skin burn.
- Do not operate your computer or charge the battery near flammable materials or in explosive environments.
- Ventilation slots, fans and/or heat sinks are provided with the product for safety, comfort, and reliable operation. These features might inadvertently become blocked by placing the product on a bed, sofa, carpet, or other flexible surface. Never block, cover or disable these features.

CD and DVD drives spin discs at a high speed. If a CD or DVD is cracked or otherwise physically damaged, it is possible for the disc to break apart or even shatter when the CD drive is in use. To protect against possible injury due to this situation, and to reduce the risk of damage to your machine, do the following:

- Always store CD/DVD discs in their original packaging
- Always store CD/DVD discs out of direct sunlight and away from direct heat sources
- Remove CD/DVD discs from the computer when not in use
- Do not bend or flex CD/DVD discs, or force them into the computer or their packaging
- Check CD/DVD discs for cracks before each use. Do not use cracked or damaged discs

# Setting up the monitor

---

## Product description

The IBM ThinkVision Monitor, L180p, is a TFT LCD Color Monitor. It requires a computer with a suitable on-board sub-system or Video Adapter card that can support SXGA 1280 x 1024, XGA 1024 x 768, SVGA 800 x 600, or VGA 640 x 480 at 60Hz.

In addition to your monitor, your option package includes the following:

- User's Guide and Installation Files CD
  - Monitor Safety and Warranty Information Manual
  - IBM ThinkVision Monitor L180p Setup Guide
  - Power Cord
  - L180p ThinkVision Monitor
  - Analog Interface Cable - Attached to Monitor
  - Digital Interface Cable - not Attached to Monitor
- 

## Handling instructions

*Do not support the monitor within the screen area. The Liquid Crystal Display is glass and can be damaged by rough handling or excessive pressure.*

1. Lift the monitor by placing your hands where indicated by the arrows in the figure below. An alternative is to use the handle feature on the back of the monitor. See Figure A below.

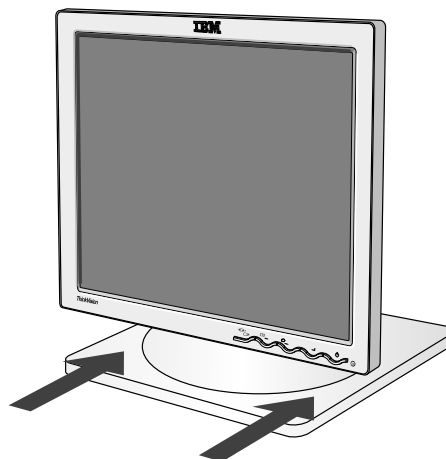

2. Before using your monitor for the first time, remove the clear protective film from the front of the screen.

- 
3. Before adjusting your monitor for the first time, remove the locking clip on rear of the stand. Carefully hold the screen of the monitor and squeeze the locking clip to remove. This action is shown in Figure A.

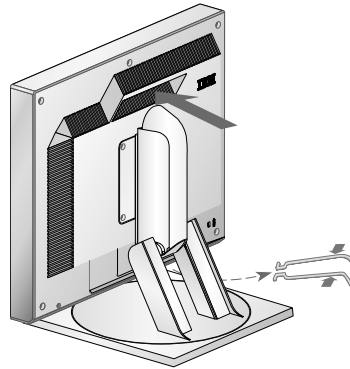
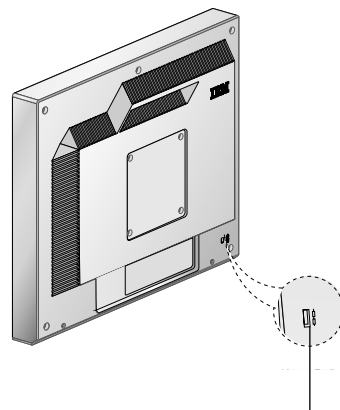

Figure A

---

## Kensington security slot

This slot can be used to connect to a locking cable. Locking cables can be purchased separately at most computer stores.



Kensington security slot



---

## Workplace preparation

**i** This section gives advice on what you should consider before you set up your monitor.

### Height

Position the monitor so that the top of the screen is slightly below your eye level when you sit at your workstation.

### Orientation

1. Choose a position that gives the least reflection from lights and windows, usually at a right angle to any windows.
2. Position the monitor directly in front of you so that you do not have to twist your body to use it.
3. Tilt the monitor to a comfortable viewing angle.

---

## Adjusting the monitor position

**i** With the IBM Flat Panel Monitor, you can adjust its position in various ways for maximum comfort.

### Viewing angle

You can tilt the screen forward and backward as shown below in Figure A.

### Swivel

You can swivel the screen to the left or the right as shown below in Figure A.

### Height

You can adjust height of the screen as shown below in Figure B.

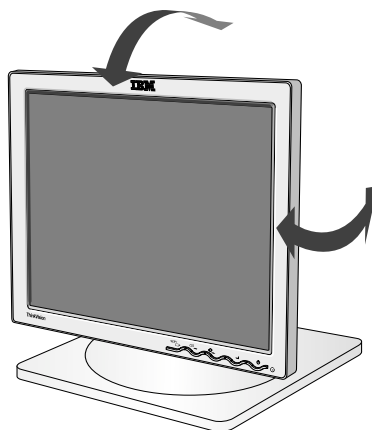

Figure A

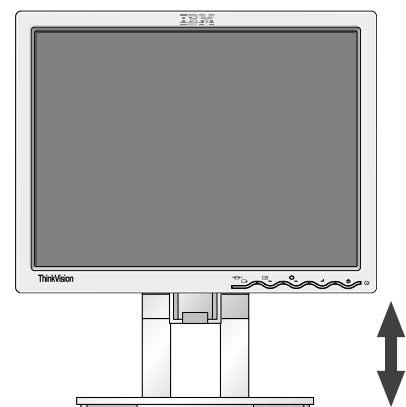

Figure B

---

## Working practices

**i** This section gives advice on how you can work comfortably and reduce fatigue.

### Rest

Take regular breaks. Vary your posture, stand up and stretch occasionally as prolonged use of computer workstations can be tiring.

### Back

Sit back in your chair and use the backrest.

### Hands

Use a light touch on the keyboard and keep your hands and fingers relaxed. Your upper arms should be relaxed with your elbows near your body.

Use a light touch on the keyboard, keeping your hands and fingers relaxed. Allow a space in front of the keyboard to rest your wrists when not typing. Consider using a wristpad.

### Eyesight

Working with monitors, in common with any prolonged close work, can be visually demanding. Look away from the screen periodically and have your eyesight checked regularly.

### Screen settings

Set the screen brightness and contrast to a comfortable level. You may have to adjust these settings as the lighting changes during the day. Many application programs let you select color combinations which can help you to view in comfort. See the User controls section on page 18 for more information.

---

## Caring for your monitor

Be sure to turn off the power before you perform any maintenance on the monitor. Clean your monitor as follows:

- Do not use solvents or abrasives.
- Gently wipe the covers and the screen with a soft cloth.
- Remove finger marks and grease with a damp cloth and mild detergent.
- Never use flammable cleaning materials to clean your IBM monitor or any other electrical apparatus.

## Connecting your monitor

*Be sure to read the Safety Information located in the Monitor Safety and Warranty Information Manual before carrying out this procedure.*

1. Turn off your computer and all attached devices. Next, unplug all power cords to your computer and all attached devices.
2. Connect the signal cable.
  - The analog signal cable is already connected to your monitor (See ❶ in Figure A).
  - When connecting the analog signal cable, connect the free end of the attached signal cable to the 15-pin monitor port on the computer and tighten screws. ❷

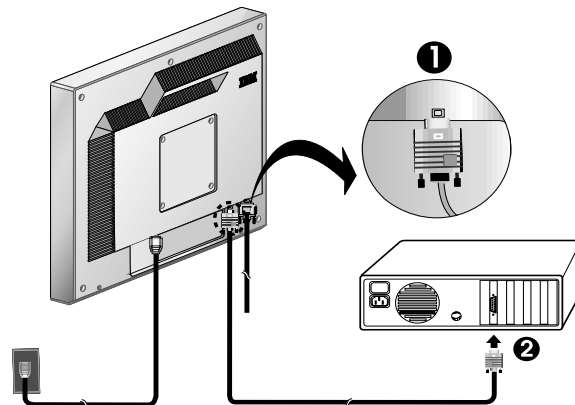

Figure A

- If you are connecting a DVI-D digital signal cable, follow Figure B. Connect one end of the monitor signal cable to the white connector ❶ on the rear panel of the monitor. Connect the other end to the white connector ❷ on the rear panel of the computer and tighten the screws.

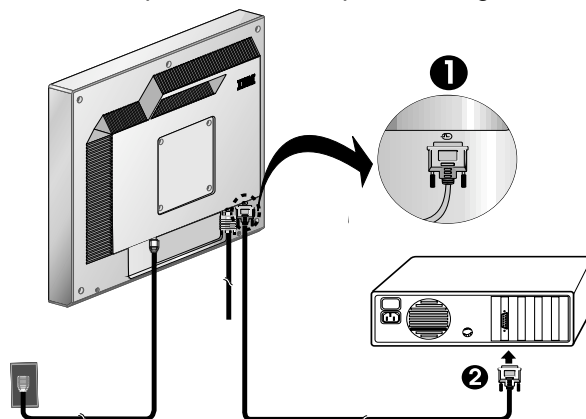

Figure B

- 
3. Connect the power cord to the monitor and then plug the power cord into a properly grounded outlet. Next, reconnect the power cords to your computer and all attached devices.
- 

## **Switching on your monitor**

1. Switch on your computer.
2. Switch on your monitor by pushing and releasing the power switch marked "⏻" at the front of the bezel.
  - To switch off your monitor, push and release the power switch again.
3. To update or install device drivers, follow the instructions in the Device driver installation section on page 11.
4. If you are using the analog connector, run Image setup by following the instructions in the Automatic Image setup section on page 14.

# Device driver installation

## Installing the device driver in Windows 95 or Windows 98

*This section must be completed before continuing with the Windows 95 or Windows 98 Image setup on page 14.*

**i** *On LCD monitors, unlike CRTs, a faster refresh rate does not improve display quality. For optimal performance, use either 1280 x 1024 at a refresh rate of 60Hz or 640 x 480 at a refresh rate of 60Hz.*

To install the device driver in Microsoft® Windows® 95 or Windows 98, do the following:

**Note:**

You must download files from the *User's Guide and Installation Files CD* to use the Plug and Play feature in Windows 95 or Windows 98.

1. Turn off the computer and all attached devices.
2. Ensure that the monitor is connected correctly.
3. Turn on the monitor and then the system unit. Allow your computer to start the Windows 95 or Windows 98 operating system.

Your computer's Plug and Play code might warn you that your system hardware has changed. This means that it has detected your new monitor for the first time.

4. Open the Display Properties window by clicking **Start -> Settings -> Control Panel** and then double-clicking on the **Display** icon.
5. Click the **Settings** tab.
6. If you are using Windows 95, complete the following steps:
  - a. Click the **Change Display Type** button.
  - b. Click the **Change Monitor Type** button.
  - c. Proceed to Step 7.
 If you are using Windows 98, complete the following steps:
  - a. Click the **Advanced** button.
  - b. Click the **Monitor** tab.
  - c. Open the Update Device Driver Wizard window by clicking on the **Change** button and then select the **Next** button.
  - d. Select **Display a list of the known drivers for this device so that I can choose a specific driver** and then select the **Next** button.
  - e. Proceed to Step 7.
7. Insert the *User's Guide and Installation Files CD* into the CD drive and click the **Have Disk** button.
8. Click **OK**.
9. Ensure that the CD drive letter is selected, and then select the **DRIVERS** folder.
10. Select **IBM L180p monitor** and click **OK**. The files will be copied from the CD to your hard disk drive.
11. Close all open windows and remove the CD.
12. Restart the computer.

The system will automatically select the maximum refresh rate and corresponding Color Matching Profiles.

---

## Installing the device driver in Windows 2000 or Windows Me

*This section must be completed before continuing with the Windows 2000, Windows Me Image setup on page 14.*

**i** *On LCD monitors, unlike CRTs, a faster refresh rate does not improve display quality. For optimal performance, use either 1280 x 1024 at a refresh rate of 60Hz or 640 x 480 at a refresh rate of 60Hz.*

To install the device driver in Microsoft Windows 2000 Professional or Microsoft Windows Millennium Edition (Me), do the following:

**Note:**

You must download files from the *User's Guide and Installation Files CD* to use the Plug and Play feature in Windows 2000 or Windows Me.

1. Turn off the computer and all attached devices.
2. Ensure that the monitor is connected correctly.
3. Turn on the monitor and then the system unit. Allow your computer to start the Windows 2000 or Windows Me operating system.
4. Open the Display Properties window by clicking **Start -> Settings -> Control Panel** and then double-clicking on the **Display** icon.
5. Click the **Settings** tab.
6. Click the **Advanced** button.
7. Click the **Monitor** tab.
8. Click the **Properties** button.
9. Click the **Driver** tab.
10. Open the Upgrade Device Driver Wizard window by clicking on **Update Driver** and then click the **Next** button.
11. Select **Display a list of the known drivers for this device so that I can choose a specific driver** and then click the **Next** button.
12. Insert the Monitor CD into the CD drive and click the **Have Disk** button.
13. Click **OK**.
14. Ensure that the CD drive letter is selected, and then select the **DRIVERS** folder.
15. Select IBM L180p monitor and click **OK**. The files will be copied from the CD to your hard disk drive.
16. Close all open windows and remove the CD.
17. Restart the computer.

The system will automatically select the maximum refresh rate and corresponding Color Matching Profiles.

## Installing the device driver in Windows XP

*This section must be completed before continuing with the Windows XP Image Setup on page 14.*

**i** *On LCD monitors, unlike CRTs, a faster refresh rate does not improve display quality. For optimal performance, use either 1280 x 1024 at a refresh rate of 60Hz or 640 x 480 at a refresh rate of 60Hz.*

To install the device driver in Windows XP, do the following:

**Note:**

You must download files from the *User's Guide and Installation Files CD* to use the Plug and Play feature in Windows XP.

1. Turn off the computer and all attached devices.
2. Ensure that the monitor is connected correctly.
3. Turn on the monitor and then the system unit. Allow your computer to start the Windows XP operating system.
4. Open the Display Properties window by clicking **Start -> Settings -> Control Panel** and then double-clicking on the **Display** icon.
5. Click the **Settings** tab.
6. Click the **Advanced** button.
7. Click the **Monitor** tab.
8. Click the **Properties** button.
9. Click the **Driver** tab.
10. Open the Hardware Update Wizard window by clicking on **Update Driver** and then click the **Next** button.
11. Select **Install from a list or Specific location(Advanced)** and then click the **Next** button.
12. Insert the Monitor CD into the CD drive and click the **Have Disk** button.
13. Click **OK**.
14. Ensure that the CD drive letter is selected, and then select the **DRIVERS** folder.
15. Select **IBM L180p monitor** and click **OK**. The files will be copied from the CD to your hard disk drive.
16. Close all open windows and remove the CD.
17. Restart the computer.

The system will automatically select the maximum refresh rate and corresponding Color Matching Profiles.

# Automatic Image setup

---

## Image setup

**Before carrying out this section, it is very important that the correct monitor drivers have been installed. (See pages 11 and 13.)**

**i** The Setup Utility included on the setup CD displays a test pattern of dots. It does not replace or modify the display drivers.

**i** The Image setup instructions require the monitor to be warmed up for 15 minutes. This is not required for normal operation.

**i** If your computer does not run with the setup CD shipped with the monitor, refer to Manual Image setup on page 17.

**i** The Image setup process only applies to the current screen mode. When a new mode is selected, repeat this section to reset the monitor.

For digital input, image setup is not required.

When you first use your monitor, you must perform Auto Setup for analog input. If you are using digital input, continue with the instructions on page 9. This procedure sets up your monitor to process the video signals from your computer without image discoloration or smearing. After you perform Auto Setup, the settings are stored and used each time you turn on the monitor.

In order to optimize the displayed image a set-up utility is provided on the IBM Monitor CD. Operation of this utility is dependent on the operating system on your computer. You may choose to run Image setup for each operating system that you use. This means that if you sometimes use your monitor while running any version of Windows and sometimes also use it from within DOS (not a DOS window), you must run Image setup for both Windows and DOS. You may run versions of Image setup in any order.

Before you begin Image setup for your computer, make sure the computer video mode is set in the range of the supported screen resolution shown in the table on page 22.

You should perform Image setup for each screen mode you use.



## Image setup for DOS

**i** If the monitor is in standby mode, it may automatically turn off while you are waiting for it to warm up. If this happens, switch off the monitor and switch it on again after a few seconds.

**i** If you are using PC-DOS/V, change to U.S. mode by typing CHEV US and pressing **enter** at the command prompt.

**i** The size and diversity of the dot pattern varies with the screen resolution.

**i** If the screen flickers, repeat the setup several times until the flicker is minimized, or adjust it manually by following refer to Manual Image setup on page 17.

To set up the monitor automatically in DOS, do the following.

1. Turn on the monitor first; then turn on the computer.  
If the message "check signal cable" is displayed, or if nothing is displayed, check:
  - That the video interface cable is not connected properly.
  - The correct video adapter card is not installed.
  - The correct supported display mode is selected for your computer.
2. Wait approximately 15 minutes for the monitor to warm up.
3. Insert the *User's Guide and Installation Files CD* into the computer's CD-ROM drive.
4. Display the command prompt screen of the DOS full-screen display.
5. Type `d:\TESTPAD` where d is the letter of the CD-ROM drive.
6. Press enter.
7. Select the number for the color or text mode you want to set up.
8. Select the number for the video mode you want to set up. You can repeat this process for as many of the color and video modes as you need.
9. When the dot pattern appears, press the "↵" button at the bottom of the monitor. This activates the Auto setup procedure, which will optimize the display settings with the provided dot-patterns.  
The screen will momentarily turn black while auto adjustment proceeds.
10. When finished, the Image setup message disappears and the screen returns to a normal display.
11. To clear the Image setup test pattern, press the Esc key on your keyboard.
12. Type `Exit` at the command prompt to return to Windows.

If you use other operating systems, perform the appropriate Auto setup for those systems using instructions given in Image setup Windows 95, Windows 98, Windows NT, Windows 2000, Windows Me, or Windows XP on page 16.

## Image setup for Windows 95, Windows 98, Windows NT, Windows 2000, Windows Me, or Windows XP

**i** If the monitor is in standby mode, it may automatically turn off while you are waiting for it to warm up.

To set up the monitor automatically in Windows 95, Windows 98, Windows NT, Windows 2000, Windows Me, or Windows XP, do the following:

1. Turn on the monitor first; then turn on the computer.  
If the message "check signal cable" is displayed, or if nothing is displayed, check:
  - That the video interface cable is not connected properly.
  - The correct video adapter card is not installed.
  - The correct supported display mode is selected for your computer.
2. Wait approximately 15 minutes for the monitor to warm up.
3. If the icon bar and tool bar are displayed, drag them to the bottom of the screen.
4. Insert the *User's Guide and Installation Files CD* into the computer's CD-ROM drive.
5. Check the operating system installed on your computer and follow the instructions from the table below.

**Operating system installation steps**

Operating System	Step 1	Step 2	Step 3
Windows 95	Open program manager	Select RUN	Type e : \TESTPAT where e is the letter of your CD-ROM drive, then press Enter.
Windows 98, Windows 2000, Windows NT, Windows Me or Windows XP	Select START		

6. When the dot pattern appears, press the "⏏" button at the bottom of the monitor. This activates the Image setup procedure, which will optimize the display settings with the provided dot-patterns.
  - The screen will momentarily turn black while auto adjustment proceeds.
7. When finished, the Image setup message disappears and the screen returns to a normal display.
8. To clear the Image setup test pattern, press the Esc key on your keyboard.

You have completed the monitor setup for Windows. If you are using the DOS operating system, go to "Image setup for DOS on page" 15.

**i** The size and diversity of the dot pattern varies with the screen resolution.











# Manual Image setup

---

**i** If the monitor is in standby mode, it might automatically turn off while you are waiting for it to warm up.

Normally, you can complete the setup procedure using Automatic Image setup; however, if your screen image is still distorted after you perform Image setup or the setup CD does not run on your system, perform Manual Image setup.

To manually adjust the image setting, do the following:

1. Turn on the monitor and wait approximately 15 minutes for it to warm up.
2. Display the image you most frequently use on the screen.
3. Press the OSD Enter button " " at the bottom of the monitor to display the initial OSD menu.
4. Use the Right Arrow button " " to select the Image setup icon " " and press the OSD Enter button " " to access the function.
5. Use the Right Arrow button " ", to select to manual. Press the OK button " " twice to select clock.
6. Use the Arrow buttons to manually adjust to correct for jitter or noise in the image. Press OK button " ".
7. Press OK " " and use Arrow buttons to adjust phase, press OK " ". Press OK " " again to Save and Exit. Then press Exit button " " twice to exit OSD.

You have completed the monitor setup.

# Adjusting your LCD monitor





## User controls

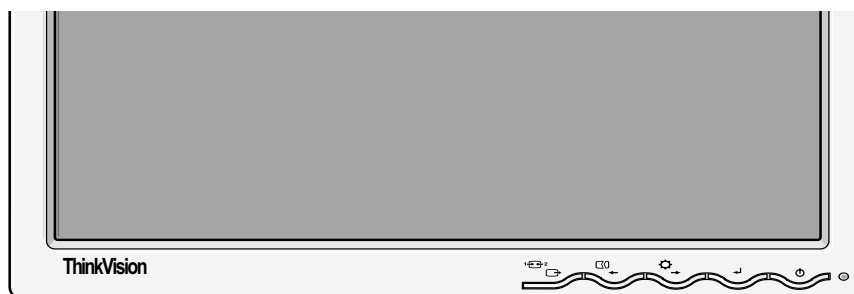

***i** The image is already optimized for many display modes, however the user controls can be used to adjust the image to your liking.*

***i** The settings are saved after adjustment and when exiting the OSD and will be effective thereafter.*



## USER CONTROL FEATURES

Icon	Monitor controls
	Switches the monitors on and off.
	Display main OSD menu and selects highlighted menu item.
	Moved the cursor to highlight icons or make adjustments.
	Exits from current OSD menu.

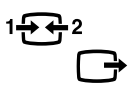
Icon	Direct Access Functions
	Bring up Brightness adjustment.
	Executes automatic image setup.
	<p><b>CONTROLS LOCK / UNLOCK</b></p> <p>This feature allows you to secure the current control settings, while allowing the user to adjust Brightness, so that they cannot be inadvertently changed. Push and hold the enter button[↵] for 10 seconds; the message "Menu is Locked" appears. You can unlock the OSD controls at any time by pushing the enter button[↵] for 10 seconds; the message "Menu is Unlocked" will appear.</p>
	Switch between input signals.

## On-screen display (OSD) controls

**i** The LCD monitor needs time to become thermally stable the first time you turn it on each day. Thus, to achieve more accurate adjustments for parameters, allow the LCD monitor to warm up for at least 15 minutes before making any screen adjustment.

The settings adjustable with the user controls are viewed through the On - Screen Display (OSD). Press the enter button "↵" to display the main OSD menu.

### Initial appearance of OSD

#### Main menu



#### Sub menu

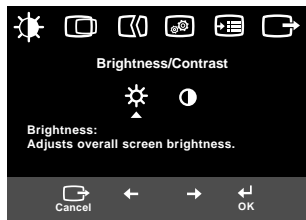



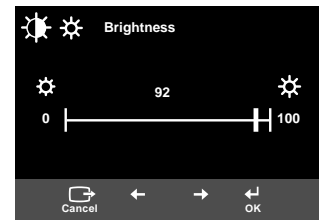













#### Adjustment screen



### OSD functions

OSD Icon		Description	Sub menus	Control and Adjustments	
				Analog	Digital
 Brightness / Contrast	 Brightness	Adjusts brightness		 	
	 Contrast	Adjusts contrast		 	
 Image Position	 Horizontal Position	Moves the screen left and right.		 	Control Locked
	 Vertical Position	Moves the screen up and down.		 	Control Locked

OSD Icon		Description	Sub-menu(s)	Controls and Adjustments	
				Analog	Digital
 <b>Image Setup</b>	 <b>Automatic</b>	The Image setup function is used to adjust the level of noise in the video signal which causes horizontal lines or areas on the screen where the image appears to be unstable and jitters or shimmers. This can be done automatically or manually.		If <b>Auto</b> is selected the image will automatically adjust	Control Locked
	 <b>Manual</b>	If manual is selected, the user will go to the manual adjustment screen.	<ul style="list-style-type: none"> <li>• <b>Clock</b></li> <li>• <b>Phase</b></li> <li>• <b>Save</b></li> </ul>	To adjust the focus of the display. This item allows you to remove any horizontal noise and clear or sharpen the image of characters.	Control Locked
 <b>Image Properties</b>	 <b>Color</b>	Select the Color mode you find most comfortable or fine tune the colors using the Custom menu, if necessary.	<b>Preset</b> <ul style="list-style-type: none"> <li>• 6500K (Pink White)</li> <li>• 7200K (Normal White)</li> <li>• 9300K (Blue White)</li> </ul>		
			<b>Custom</b> <ul style="list-style-type: none"> <li>• R</li> <li>• G</li> <li>• B</li> <li>• Save</li> </ul>	Increases or decreases redness	Increases or decreases greenness

OSD Icon	Description	Sub-menu(s)	Controls and Adjustments	
			Analog	Digital
 <b>Image Properties</b>	 <b>Input Signal</b>	<p>Use this button to make the analog or digital connector active. This feature is used when two computers are connected to the monitor. The default setting is analog.</p> <p>1    Analog</p> <p>2    Analog</p> <p>2    Digital</p>		
 <b>Options</b>	 <b>Information</b>	<p>Display the detailed information of mode, model name, serial number and microcode.</p>		
	 <b>Menu Language</b>	<p>The language chosen affects only the language of the OSD. Select one of the six language to use for the OSD. It has no effect on any software running on the computer.</p>	<ul style="list-style-type: none"> <li>• English</li> <li>• Français</li> <li>• Italiano</li> <li>• Deutsch</li> <li>• Español</li> <li>• 日本語</li> </ul>	
	 <b>Menu Position</b>	<p>Changes the position of the OSD on the screen.</p>	<ul style="list-style-type: none"> <li>• <b>Default</b></li> </ul>	Move at center on the screen.
			<ul style="list-style-type: none"> <li>• <b>Custom</b></li> <li>• H</li> <li>• V</li> <li>• Save</li> </ul>	
	 <b>Factory Default</b>	<p>Reset should return all available functions (apart from language which should not change unless adjusted via the Language menu) to their factory presets.</p>	<ul style="list-style-type: none"> <li>• <b>Cancel</b></li> <li>• <b>Reset</b></li> </ul>	
 <b>Accessibility</b>	<p>Change button repeat rate and menu time-out setting.</p>	<ul style="list-style-type: none"> <li>• <b>Button repeat rate</b></li> <li>• Off</li> <li>• Default</li> <li>• Slow</li> </ul>	Adjusts response speed of button.	
		<ul style="list-style-type: none"> <li>• <b>Menu time out</b></li> </ul>	Adjusts the length of time for which the menu will stay on the screen before it disappears.	
 <b>Exit</b>	<p>Exits from current OSD menu.</p>			

# Further information

---

## Display modes

***i** If your computer has previously been used with a CRT monitor and is currently configured to a display mode outside the range that the Flat Panel monitor can display, you may need to re-attach the CRT monitor temporarily until you have reconfigured the computer, preferably to 1280 x 1024 at 60Hz.*

The display mode the monitor uses is controlled by the computer. Therefore, you should refer to your computer documentation for details on how to change display modes.

The image size, position and shape may change when the display mode changes. This is normal and the image can be readjusted using Image setup and the monitor controls.

Unlike CRT monitors, which require a high refresh rate to minimize flicker, TFT technology is inherently flicker-free. If possible, configure your computer for 1280 x 1024 addressability at 60Hz vertical refresh rate.

For the display modes listed below, the screen image has been optimized during manufacture.

### Factory Set Display Modes

Addressability	Refresh Rate	Horizontal Frequency
640 x 480	60 Hz	31.5 kHz
640 x 480	75 Hz	37.5 kHz
640 x 350	70 Hz	31.5 kHz
720 x 400	70 Hz	31.5 kHz
800 x 600	60 Hz	37.9 kHz
800 x 600	75 Hz	46.9 kHz
832 x 624	75 Hz	49.7 kHz
1024 x 768	60 Hz	48.4 kHz
1024 x 768	75 Hz	60.0 kHz
1152 x 870	75 Hz	68.7 kHz
1152 x 900	66 Hz	61.8 kHz
1280 x 1024 †	60 Hz	63.98 kHz
1280 x 1024	75 Hz	79.98 kHz

Note: VESA timings are as detailed in the VESA "Display Monitor Timing Specification". Version 1.0, Revision 0.8, Dated 09/17/98.

† Recommended

†† D-sub Analog only



## Power management

To benefit from power management, the monitor must be used in conjunction with a computer that implements the Video Electronics Standards Association (VESA) Display Power Management Signaling (DPMS) Standard.

The power management feature is invoked when the computer recognizes that you have not used your mouse or keyboard for a user-definable period. There are several states as described in the table below.

As an Energy Star 2000® Partner, IBM has determined that this product meets the Energy Star 2000 guidelines for energy efficiency.

For optimal performance switch off your monitor at the end of each working day, or whenever you expect to leave it unused for long periods during the day.

State	Power Indicator	Screen	Restoring Operation	Compliance
<b>On</b>	Steady green	Normal		
<b>Active off</b>	Steady amber	Blank	Press a key or move the mouse.*	ENERGY STAR 2000

\* There may be a slight delay before the picture reappears.

## Product disposal

The fluorescent lamps in the liquid crystal display contain a small amount of mercury. Dispose of it as required by local ordinances and regulations.

# Arm or wall mounting

## Removing the stand and cables

**i** Be sure to read the Monitor Safety and Warranty Information manual that comes with your monitor before changing stands or cables.

Alternative stands for your IBM Flat Panel Monitor may be available from specialist suppliers.

This product is equipped with mounting facilities that conform to the VESA Flat Panel Monitor Physical Mounting Interface Standard (FPMPMI). When using the VESA standard mounting plate, connect the monitor to the wall or to the arm mounting device. Use other cables for reasons such as having the monitor wall-mounted, follow the instructions below:

1. Power off the monitor. Next, disconnect the power cord and then the signal cable to the monitor.
2. Lay the monitor facedown on a cushion and remove the four screws holding the hinge mechanism on the monitor. Refer to the diagram below for additional information on how to remove the stand.

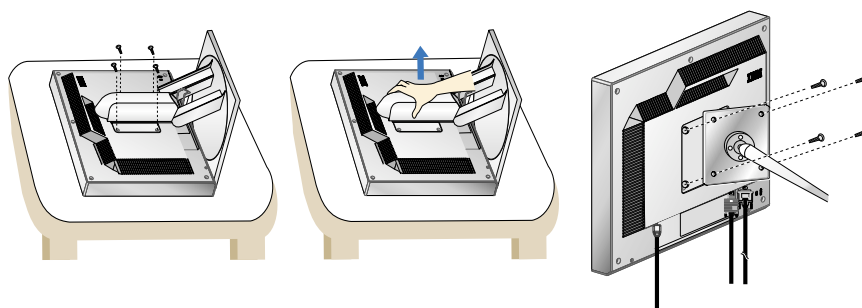

3. You have to use the four screw holes on the bottom of the stand to attach the monitor to the surface of wall. For additional information, see the instructions supplied with the purchased arm.
4. Locate a place to which you want to attach the monitor. When locating the place, you have to consider the lengths of the signal cable and the power cord.
5. Place the monitor in the location you selected in the step 4. Next, reconnect the signal cable and then the power cord to the monitor. To obtain the correct cables and/or to get further instructions on installing them, call the IBM Support Center at the above numbers or contact your dealer, retailer, or other IBM authorized service representative.

# Troubleshooting

---

If you have a problem setting up or using your monitor, you may be able to solve it yourself. Before calling your retailer or IBM, try the suggested actions that are appropriate to your problem.

<b>Problem</b>	<b>Possible Cause</b>	<b>Suggested Action</b>	<b>Reference</b>
Screen is blank and power indicator is off.	No power to monitor.	<ul style="list-style-type: none"> <li>• Ensure that the electrical outlet and the monitor are both switched on.</li> <li>• Check that the power cord is firmly plugged into the electrical outlet and the power supply unit.</li> <li>• If the power cord plug has a removable fuse, replace it.</li> <li>• Try another power cord.</li> <li>• Try another electrical outlet.</li> <li>• Check the power connection at the back of the panel.</li> </ul>	"Connecting your Monitor" section on page 9.
Screen is blank and power indicator is steady green.	Brightness and Contrast may be too low.	<ul style="list-style-type: none"> <li>• Adjust brightness and contrast.</li> </ul>	"User Controls" section on page 18.
Screen is blank and power indicator is steady amber.	The monitor is in the Power Management Standby state.	<ul style="list-style-type: none"> <li>• Press any key on the keyboard or move the mouse to restore operation.</li> <li>• Check the Power Management software on your computer.</li> <li>• Press the "↵" to switch between analog and digital mode. If the panel is the wrong mode for the signal being provided, the monitor appears to go into sleep mode.</li> </ul>	"Power Management" section on page 23.

**i** For image problems, you may want to run Image setup again before consulting to this section. In most cases, Image setup can fix the problems. See Automatic Image setup for the computer on page 14 for details.

<b>Problem</b>	<b>Possible Cause</b>	<b>Suggested Action</b>	<b>Reference</b>
Screen is blank and power indicator is flashing green every 0.5 second	Display mode of the computer is outside the range of the monitor	<ul style="list-style-type: none"> <li>• Reconfigure key on the computer to use a supported display mode.</li> </ul>	"Futher Information" section on page 22.
CHECK SIGNAL CABLE message is shown and power indicator is steady amber.	The monitor is not receiving a video signal	<ul style="list-style-type: none"> <li>• Check that the signal cable is firmly connected to the computer.</li> <li>• Check that no pins are bent in the signal cable connector.</li> </ul>	"Connecting your monitor" section on page 9.
Image appears to be smeared	There are noises in the video signal	<ul style="list-style-type: none"> <li>• Select Image setup menu in the OSD. Then select Manual to adjust Clock / Phase settings.</li> </ul>	"User Controls" section on page 20.
Image appears to be discolored	The color setting may be incorrect.	<ul style="list-style-type: none"> <li>• Adjust the Color settings.</li> </ul>	"User Controls" section on page 20.
A few dots are missing, discolored, or inappropriately lighted.	A small number of missing, discolored, or lighted dots may be present on the screen, which is an intrinsic characteristic of the TFT LCD technology and is not an LCD defect.		

---

## Help and service information

If you are unable to correct the problem yourself, you may seek further help as follows:

Call the IBM Service and Support.

In the U.S.A and Puerto Rico call 1-800-772-2227

In Canada (Toronto only) call 416-383-3344

In Canada (all other) call 1-800-565-3344

***i** If possible, stay by your computer. Your Technical Support Representative may wish to go through the problem with you during the call.*

***i** More help, late-breaking news and details of the latest accessories for these products may be found on the worldwide web at:*

*<http://www.pc.ibm.com/us/accessories>*

In other countries contact your dealer, retailer, or other IBM authorized service representative.

Before calling, please have available as much of the following information as possible:

1. Model and serial number from the label on your monitor.
2. Purchase receipt.
3. Description of problem.
4. Computer type and model.
5. System configuration (hardware fitted, etc.).
6. System BIOS version number.
7. Operating System and version number.
8. Display driver version number.
9. Video Adapter Type.

# Specifications

**i** Power consumption figures are for the monitor and the power supply combined.

This color monitor (Type-model 9180-Hxx) uses a 18.1-inch TFT LCD.

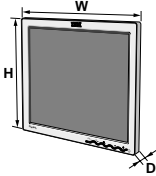
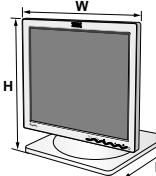
Without Stand		With Stand
 <p>Height: 330.5mm (13.01 in.) Width: 396.0mm (15.59 in.) Depth: 71.1mm (2.79 in.)</p>		 <p>Height: Lowest Position 349.7mm (13.76 in.) Height: Highest Position 449.7mm (17.70 in.) Width: 396.0mm (15.59 in.) Depth: 259.0mm (10.19 in.)</p>
Weight	Without Stand: With Stand:	5.3 kg (11.684 lbs) 7.7 kg (16.975 lbs)
Image	Viewable Image Size: Maximum Height: Maximum Width: Pixel Pitch:	18.1inch (459.74 mm) 389 mm 317.2 mm 0.28 mm (H) x 0.28 mm (V)
Power Input	Supply Voltage: Rated Current:	100 - 240 Vac 60/50 ± 3Hz 1A
Power Consumption	Normal Operation: Active off: Off:	< 55 W < 3 W < 3 W
Video Input	Input Signal:	Analog-75 ohm 0.7V Digital-DVI 1.0
	Horiz. Addressability: Vert. Addressability: Clock Frequency:	1280 pixels (max) 1024 lines (max) 108 MHz (Digital) 135 MHz (Analog)
Sync Input	Type	Analog - Separate, Composite, SOG Digital-DVI 1.0
Communications	VESA DDC:	E-DDC
Supported Display Modes	Standard modes :	IBM, VESA, MAC
	Horiz. Frequency:	Analog: 31-81 KHz
	Vert. Frequency:	Analog: 55-75 Hz
Environment	Temperature:	
	Operating:	10 to 35° C
	Storage:	- 20 to 60° C
	Shipping:	- 20 to 60° C
	Humidity:	
	Operating:	10 to 80%
Storage:	5 to 95%	
Shipping:	5 to 95%	

# Service information

---

The following parts are for use by IBM service, or IBM authorized dealers, to support the customer warranty. Parts are for service use only.

## Model Type 9180

P/N	Description	Video	Color	MTM	Geography
73P2737	FRU Monitor	Hybrid	Black	9180-HB9	WW
73P2740	FRU Stand	Hybrid	Black	9180-HB9 9180-HG9	WW
22P7936	FRU Video Interface Cable	Analog 3.0 Meter	Black	9180-HB9 9180-HG9	WW
22P7937	FRU Video Interface Cable	Digital 3.0 Meter	Black	9180-HB9 9180-HG9	WW

---

## Notices and trademarks

This section contains information on notices and trademarks.

### **Notices**

IBM may not offer the products, services, or feature discussed in this document in all countries. Consult your local IBM representative for information on the products and services currently available in your area. Any reference to an IBM product, program, or service is not intended to state or imply that only that IBM product, program, or service may be used. Any functionally equivalent product, program, or service that does not infringe any IBM intellectual property right may be used instead. However, it is the user's responsibility to evaluate and verify the operation of any non-IBM product, program, or service.

IBM may have patents or pending patent applications covering subject matter described in this document. The furnishing of this document does not give you any license to these patents. You can send license inquiries, in writing, to:

*IBM Director of Licensing  
IBM Corporation  
North Castle Drive  
Armonk, NY 10504-1785  
U.S.A*

**The following paragraph does not apply to the United Kingdom or any country where such provisions are inconsistent with local law:** INTERNATIONAL BUSINESS MACHINES CORPORATION PROVIDES THIS PUBLICATION "AS IS" WITHOUT WARRANTY OF ANY KIND, EITHER EXPRESS OR IMPLIED, INCLUDING, BUT NOT LIMITED TO, THE IMPLIED WARRANTIES OF NON-INFRINGEMENT, MERCHANTABILITY OR FITNESS FOR A PARTICULAR PURPOSE. Some states do not allow disclaimer of express or implied warranties in certain transactions, therefore, this statement may not apply to you.

This information could include technical inaccuracies or typographical errors. Changes are periodically made to the information herein; these changes will be incorporated in new editions of the publication. IBM may make improvements and/or changes in the product(s) and/or the program(s) described in this publication at any time without notice.

IBM may use or distribute any for the information you supply in any way it believes appropriate without incurring any obligation to you.

Any references in this publication to non-IBM Web sites are provided for convenience only and do not in any manner serve as an endorsement of those Web sites. The materials at those Web sites are not part of the materials for this IBM product, and use of those Web sites is at your own risk.



---

## ***Trademarks***

The following terms, used in this publication, are trademarks or service marks of the IBM Corporation in the United States, other countries, or both;

IBM

IBM logo

ThinkPad

ENERGY STAR and the ENERGY STAR logo are U.S Govt. registered trademarks.

Microsoft, Windows, and Windows NT are trademarks of Microsoft Corporation in the United States, other countries, of both.

Other company, product, and service names may be trademarks or service marks of other.

© Copyright International Business Machines Corporation 2004. All rights reserved.